

NP12-90Ah 12V90Ah

Specifications

Nominal Voltage		12V
Rated capacity (10 hour rate)		90Ah
Dimensions	Length	306±2mm(12.05inch)
	Width	169±2mm(6.65inch)
	Height	211±2mm(8.31inch)
	Total Height	215±2mm(8.46inch)
Approx. Weight		27kg(59.5lbs)±3%



Outer dimensions (mm)

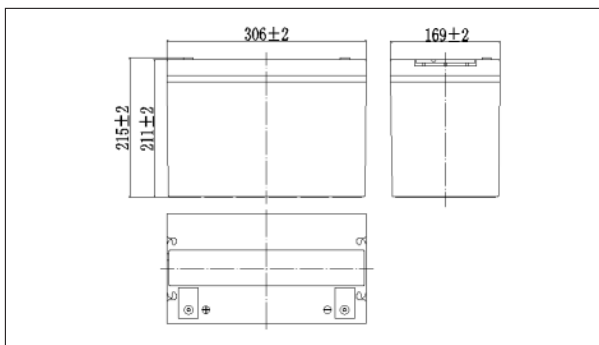

Terminal Type (mm)

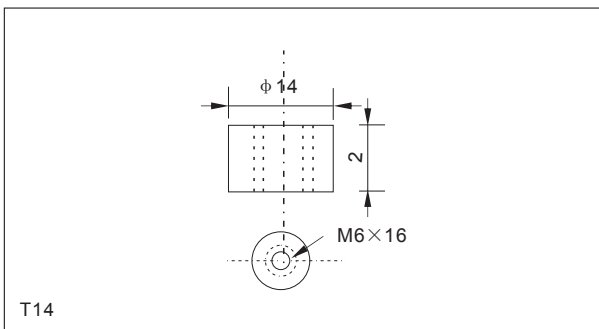

Characteristics

Capacity (25°C)	10HR(10.8V)	90Ah
	3HR(10.8V)	67.5Ah
	1HR(10.5V)	50Ah
Terminal type		T14
Internal resistance (Fully charged, 25°C)		Approx. 5mΩ
Capacity affected by temperature (10HR)	40°C	102%
	25°C	100%
	0°C	85%
	-15°C	65%
Self-discharge (25°C)	3 months	Remaining Capacity:91%
	6 months	Remaining Capacity:82%
	12 months	Remaining Capacity:65%
Nominal operating temperature		25°C ±3°C(77°F ±5°F)
Operating temperature range	Discharge	-15°C~50°C(5°F~122°F)
	Charge	-10°C~50°C(14°F~122°F)
	Storage	-20°C~50°C(-4°F~122°F)
Float charging voltage(25°C)		13.50 to 13.80V Temperature compensation: -18mV/°C
Cyclic charging voltage(25°C)		14.50 to 15.00V Temperature compensation: -30mV/°C
Maximum charging current		27A
Maximum discharge current		800A(5 sec.)
Designed floating life(20°C)		10years

Construction

Component	Positive plate	Negative plate	Container	Cover	Separator	Electrolyte	Safety valve	Terminal
Raw material	Lead dioxide	Lead	ABS	ABS	AGM	Sulfuric acid	Rubber	Copper

Constant Current Discharge Characteristics Unit:A(25°C,77°F)

F.V/Time	10min	15min	30min	60min	2h	3h	4h	5h	8h	10h	20h
9.60V	196	151	90.5	55.6	32.9	23.7	18.9	16.2	11.1	9.16	4.86
9.90V	190	148	88.6	54.8	32.7	23.5	18.8	16.1	11.0	9.14	4.85
10.2V	182	142	85.9	53.4	32.4	23.4	18.7	16.0	11.0	9.12	4.83
10.5V	175	137	83.8	51.7	31.9	23.2	18.5	15.8	10.9	9.06	4.80
10.8V	165	130	80.8	50.1	31.1	22.5	18.0	15.4	10.6	9.00	4.77

Constant Power Discharge Characteristics Unit:W(25°C,77°F)

F.V/Time	10min	15min	30min	60min	2h	3h	4h	5h	8h	10h	20h
9.60V	2119	1660	1015	634	381	279	222	191	132	109	58.3
9.90V	2055	1620	995	625	379	277	221	190	131	109	58.2
10.2V	1971	1561	964	609	375	275	220	189	130	109	58.0
10.5V	1886	1507	941	590	370	273	218	187	129	108	57.6
10.8V	1780	1428	906	571	360	265	211	182	125	107	57.2

Note: The above characteristics data can be obtained within three charge or discharge cycles.

NP12-90Ah 12V90Ah

● **Discharge characteristics(25°C)**



● **Charging characteristics (25°C)**

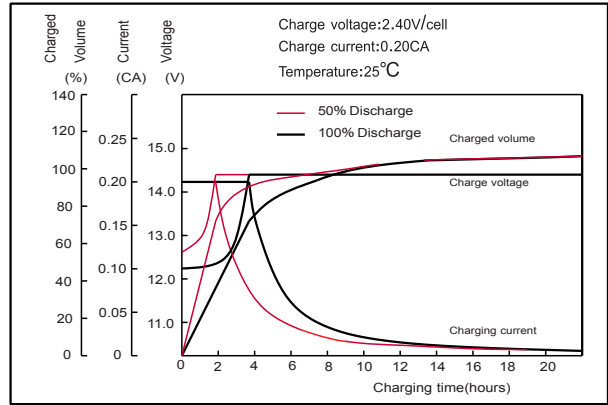

● **Temperature effects on Capacity**



● **Self-discharge characteristics**

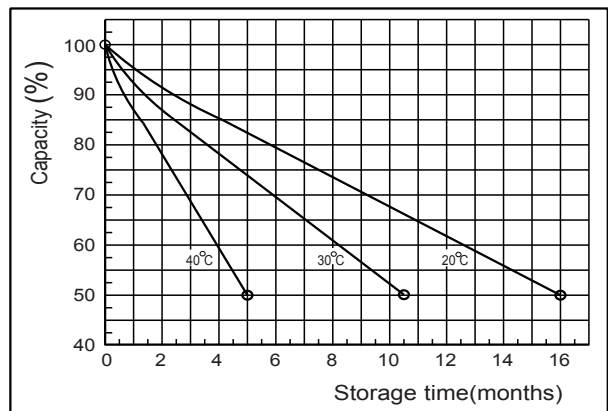

● **Floating life on Temperature**

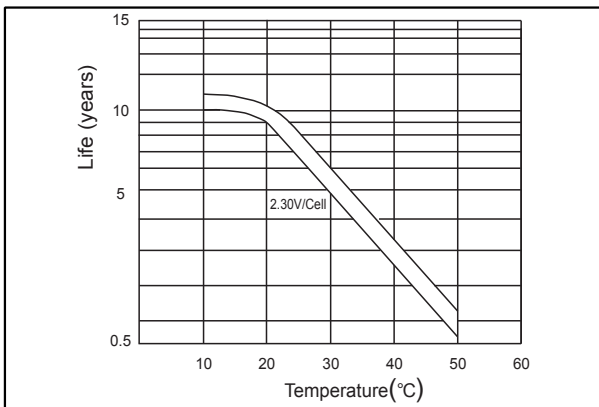

● **Cycle life on D.O.D (25°C)**

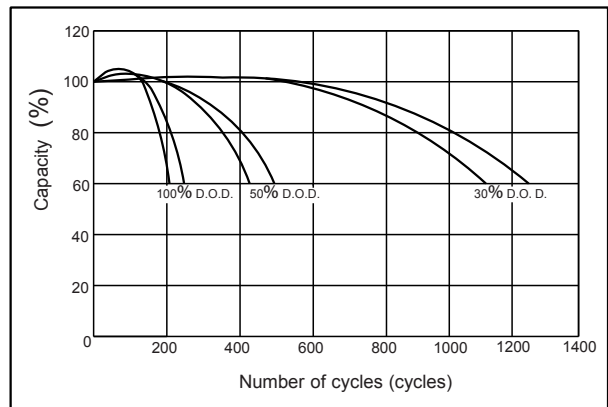

● **The relationship for OCV and Capacity (25°C)**

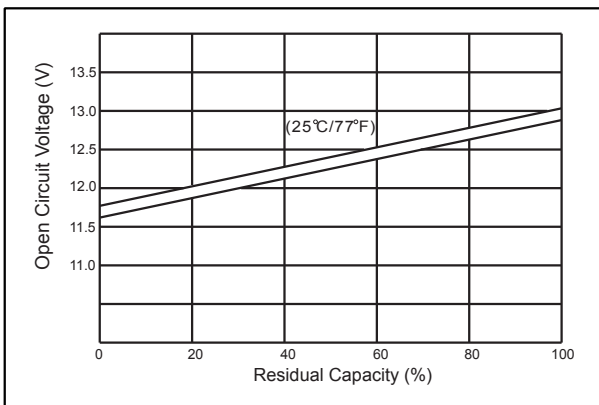

● **The relationship for Charging voltage and Temperature**

