

## HR1234W-FR (12V34 Watts/cell)

### Specifications

Nominal Voltage	12V	
Number of cell	6 cells	
Rated capacity(15min.rat)	34 Watts/cell	
Dimensions	Length	151±1.5mm(5.94inch)
	Width	65±1mm(2.56inch)
	Height	94±1mm(3.70inch)
	Total Height	100±1mm(3.90inch)
Approx. Weight	2.6kg(5.73lbs)±4%	



### Outer dimensions (mm)

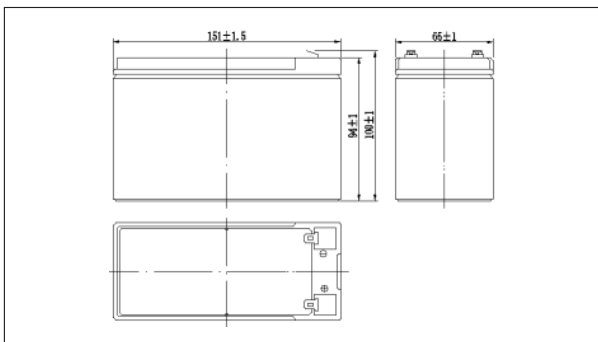

### Terminal Type (mm)

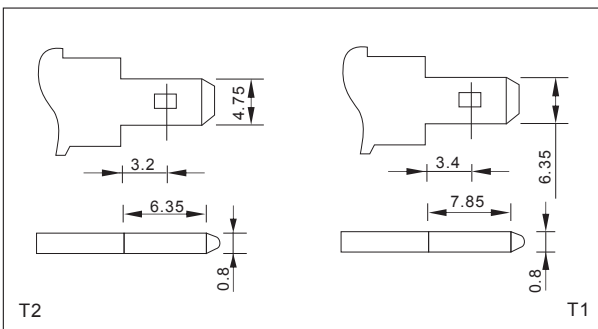

### Characteristics

Capacity(20HR,25°C)	9Ah	
Capacity(15min.rate,25°C)	34 Watts/cell	
Terminal type	T2/T1	
Internal resistance (Fully charged,25°C)	Approx. 14m Ω	
Capacity affected by temperature (20HR)	40°C	102%
	25°C	100%
	0°C	85%
	-15°C	65%
Self-discharge (25°C)	3 months	Remaining Capacity:91%
	6 months	Remaining Capacity:82%
	12 months	Remaining Capacity:65%
Nominal operating temperature	25°C ±3°C(77°F ±5°F)	
Operating temperature range	Discharge	-15°C~50°C(5°F~122°F)
	Charge	-10°C~50°C(14°F~122°F)
	Storage	-20°C~50°C(-4°F~122°F)
Float charging voltage(25°C)	13.50 to 13.80V Temperature compensation: -18mV/°C	
Cyclic charging voltage(25°C)	14.50 to 15.00V Temperature compensation: -30mV/°C	
Maximum charging current	2.7A	
Maximum discharge current	135A(5 sec.)	
Designed floating life(20°C)	5years	

### Construction

Component	Positive plate	Negative plate	Container	Cover	Separator	Electrolyte	Safety valve	Terminal
Raw material	Leaddioxide	Lead	ABS	ABS	AGM	Sulfuric acid	Rubber	Copper

### Constant Current Discharge Characteristics Unit:A(25°C,77°F)

F.V/Time	5min	10min	15min	20min	30min	45min	60min	2h	3h	4h	5h
1.60V/cell	36.8	22.7	17.8	14.1	9.55	7.07	5.78	3.31	2.35	1.89	1.62
1.67V/cell	35.2	21.7	17.2	13.5	9.24	6.84	5.64	3.28	2.33	1.87	1.61
1.70V/cell	34.2	21.1	16.7	13.2	9.07	6.72	5.55	3.26	2.32	1.87	1.60
1.75V/cell	32.8	20.2	16.2	12.8	8.85	6.55	5.44	3.21	2.30	1.85	1.59
1.80V/cell	30.9	19.0	15.3	12.1	8.53	6.31	5.27	3.13	2.23	1.80	1.55

### Constant Power Discharge Characteristics Unit:W(25°C,77°F)

F.V/Time	5min	10min	15min	20min	30min	45min	60min	2h	3h	4h	5h
1.60V/cell	70.7	44.0	35.3	27.9	18.9	14.0	11.5	6.58	4.72	3.80	3.27
1.67V/cell	67.5	42.0	34.0	26.8	18.3	13.5	11.2	6.52	4.68	3.77	3.24
1.70V/cell	65.7	40.9	33.1	26.2	18.0	13.3	11.0	6.48	4.66	3.75	3.22
1.75V/cell	62.9	39.1	32.0	25.3	17.5	13.0	10.8	6.39	4.63	3.73	3.20
1.80V/cell	59.4	37.0	30.3	24.0	16.9	12.5	10.4	6.22	4.49	3.61	3.11

Note: The above characteristics data can be obtained within three charge or discharge cycles.

**HR1234W-FR (12V34 Watts/cell)**

**Discharge characteristics(25°C)**



**Charging characteristics (25°C)**

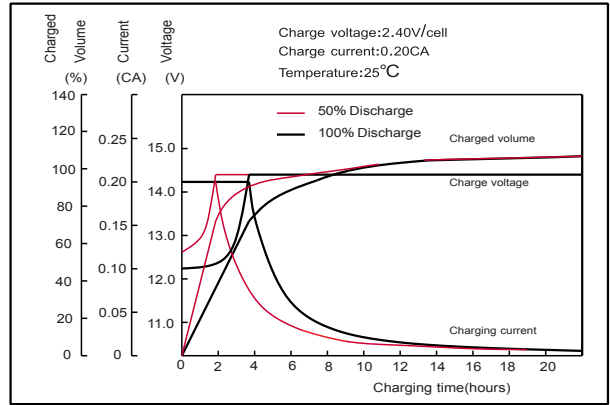

**Effect of Temperature on Capacity**

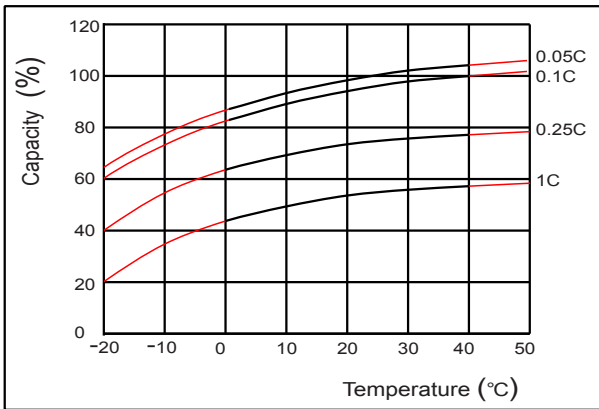

**Self-discharge characteristics**

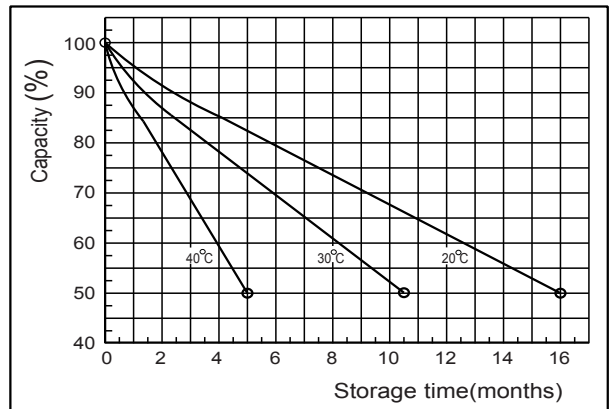

**Floating Life on Temperature**

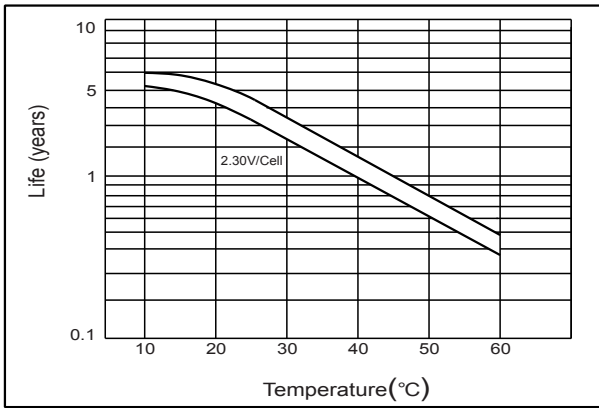

**Cycle service Life on D.O.D (25°C)**

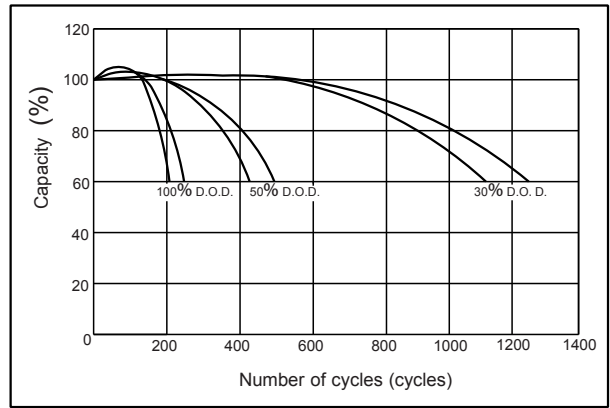

**The relationship for OCV and Capacity (25°C)**

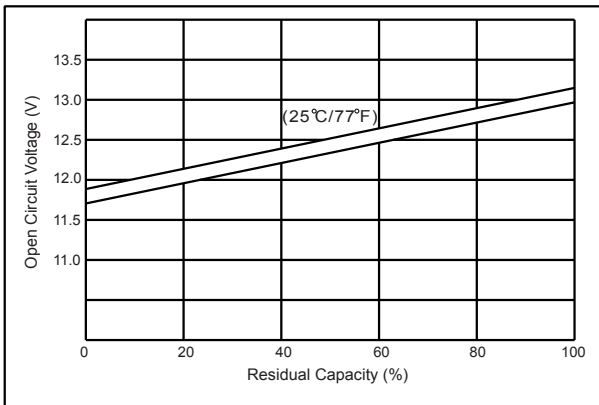

**The relationship for Charging voltage and Temperature**

